

Trench Roller RT16



Operator's Manual



**THIRD
COAST**
EQUIPMENT

THIRDCOASTEQUIPMENT.COM

©2024 by Third Coast Equipment, Inc. All rights reserved.

All trademarks referenced in this manual are the property of their respective owners.

No portion of this manual may be reproduced without written permission from Third Coast Equipment, Inc.

To reduce the risk of injury, all operators and maintenance personnel must read and understand their machine's instruction manual in full before operating, changing accessories, or performing maintenance on that machine.

CONTENTS

Introduction	1
Applications	1
Hazard & Notice Iconography	2
Machine Label Locations	2
Machine Labels	3
Hazards & Risks	4
California Proposition 65 Warning	4
General Hazards & Risks	4
Transportation Hazards	4
Mechanical Hazards	5
Fire, Explosion & Thermal Hazards	5
Chemical Hazards	5
Noise Hazards	6
Personal Protective Equipment & Human Health Hazards	6
Additional Hazards	6
Operation	7
Familiarization with the Trench Roller & its Components	7
Daily Pre-Operation Inspection	7
Starting the Roller	8
Operating the Trench Roller	8
Powering Off the Trench Roller	9
Emergency Shutdown Procedure	9
Adding or Removing the Drum Extensions	9
Tips for Proper Compaction	10
Extended Storage	11
Lifting & Transportation	11
Care & Preventative Maintenance	12
Machine Inspection Intervals	12
Engine Inspection & Maintenance Tables	13
Tightening Torque Tables	14
Service Parts & Fluids Tables	14
Specifications	15
Wiring Diagrams	16
Hydraulic Schematic	17
Troubleshooting	17
Warranty	19

INTRODUCTION

Thank you for your purchase of this Third Coast Equipment, Inc. (“Third Coast”) trench roller. Please read this operator’s manual in its entirety prior to using your new machine. This manual provides information pertaining to the safe use, proper operation, and routine maintenance of this machine. All operators and maintenance personnel must read and understand this manual in full before operating, changing accessories, or performing maintenance on this machine.

This manual is written for Third Coast machines in production at the time of publication, and Third Coast reserves the right to change any portion of this manual at any time without notice to reflect any changes to current production machine configurations or updates to regulatory compliance or for any other reason deemed appropriate by Third Coast.

The latest revision of this manual can be obtained by visiting us online at:

THIRDCOASTEQUIPMENT.COM

APPLICATIONS

Trench rollers excel in confined area compaction. Controlled by radio frequency remote control, this Third Coast trench roller does not require the operator to be in physical contact with the machine. When used in trenches, this means the operator can stand at grade while the machine works below grade, improving operator safety.

The use of radio frequency remote controlled operation improves communication between the operator and the machine by removing the line-of-sight requirement found on traditional infrared remote controlled trench rollers. Radio frequency not only operates with greater stability and over longer distances, but also operates through objects on the jobsite such as trench shoring cross bars, which can block traditional infrared systems.

By removing line-of-sight restrictions, the operator of this radio frequency equipped trench roller can choose the best path for walking alongside the machine based on the current jobsite conditions, and need not constantly adjust their position to accommodate the equipment. The result is enhanced performance and safety for the operator.

Trench rollers excel at compacting otherwise difficult to compact substrates; this RT16 trench roller features expandable padfoot drums that are ideal for cohesive (clay mix) soils. These types of soils require the high impact forces obtained by this RT16 to properly compact and make a suitable substrate for building. Most traditional compactors cannot sufficiently compact such a substrate enough to support the weight of a building above without settling.

This trench roller is powered by a Yanmar Tier 4f diesel engine and incorporates numerous safety features such as remote operation, remote emergency stop activation, and intelligent remote control pairing.

SAFETY LABELING

HAZARD & NOTICE ICONOGRAPHY

Third Coast machines use International Standardization Organization (“ISO”) compliant iconographic labeling to depict and differentiate this machine’s dangers, warnings, and cautions (collectively referred to as “hazards”) as well as to provide non-hazard related notices.

NOTICE Indicates information not related to machine hazards, including tips for improved operation or maintenance.

CAUTION Indicates a hazard that **could** lead to minor or moderate injury if not avoided.

WARNING Indicates a hazard that **could** lead to serious injury or death if not avoided.

DANGER Indicates a hazard that **will** lead to serious injury or death if not avoided.

The one ISO label exception is the California Proposition 65 label, which per the California Office of Environmental Health Hazard Assessment (“OEHHA”) requirement is a yellow warning triangle.

All possible hazardous situations cannot be covered in any operator’s manual. Care must be exercised by everyone using, maintaining, or working on or near this equipment. If you are ever in doubt of how to safely operate or service this equipment, cease operation immediately and contact Third Coast or any Third Coast authorized dealer for assistance.

MACHINE LABEL LOCATIONS

The following labels are included on this Third Coast machine and must be maintained as part of the machine. Any label that becomes illegible through operation, wear & tear, or for any other reason must be replaced before the machine is operated, transported, or serviced.

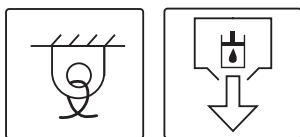

Inlet of hydraulic oil
1. Fill anti-wear hydraulic oil.
2. The filter fineness is not below 10µ

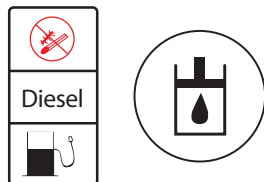

The above five labels are located inside the hydraulic system cover.





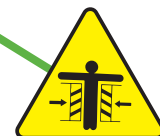

Trench Roller RT16			
kN	70	HP	25
lbs.	3604	Kg	1635
Serial No.	3CECT48122988	Manuf. Yr.	2024

THIRD COAST EQUIPMENT
THIRD COAST EQUIPMENT, Inc.
New Berlin, WI USA
www.thirdcoastequipment.com

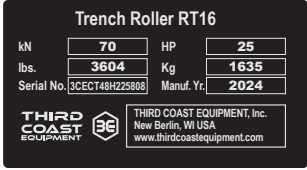

MACHINE LABELS

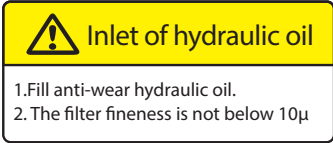
The following hazard, notice, and informational labels are included on this Third Coast machine and must be understood by all operators prior to operating this equipment.

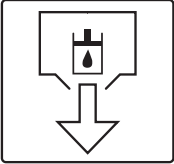
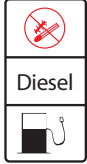
LABEL	INTERPRETATION
	<p>NAMEPLATE: The nameplate contains important information about the model, weight, gross horsepower, manufacturer, and other machine-specific information.</p>
	<p>TIE DOWN: This label identifies safe tie-down points for securing the machine for transport.</p>
	<p>HYDRAULIC OIL: This label indicates the presence of hydraulic oil.</p>
	<p>HYDRAULIC OIL INLET: This label contains information about filling the hydraulic oil tank.</p>
	<p>PINCH POINT: This label warns of a pinching hazard present at the articulation joint.</p>
	<p>LIFT POINT: This label identifies the safe lifting point for transporting the machine.</p>
	<p>HYDRAULIC OIL DRAIN: This label identifies the drain port for emptying the hydraulic oil tank.</p>
	<p>DIESEL HAZARDS: This label warns of the presence of diesel fuel and the hazard an open flame provides.</p>

Note, other labels are found on the engine of this machine, and their explanation will be provided in the engine manufacturer's operation manual.

HAZARDS & RISKS

CALIFORNIA PROPOSITION 65 WARNING

 **WARNING** Use of this product may expose you to certain chemicals, including diesel engine exhaust, which are known to the State of California to cause cancer.

GENERAL HAZARDS & RISKS

 **WARNING** General hazards are those that do not fall under a specific hazard classification, or that relate to multiple hazard classifications.

- Ensure all operators read and understand the operator's manual prior to using this machine.
- Never operate or allow anyone else to operate this machine without understanding the operational and safety controls of this machine. Even after reading the manual, new operators should receive instruction from an experienced operator.
- Never leave a machine operating while unattended.
- Use only accessories recommended by Third Coast. Any non-approved accessories may lead to operator injury or machine damage.
- Inspect this machine before every operation and at the required intervals listed in the "Care & Preventative Maintenance" section.
- Clean the machine during and after each use to ensure all safety labels remain legible. Replace any illegible safety labels before continued operation.
- Serious injury can result from improper or careless use of this machine.
- Keep this machine out of the reach of children at all times, including when not in use.

TRANSPORTATION HAZARDS

 **WARNING** Failure to adequately secure this machine while transporting and failure to lift with proper technique can result in damage to the equipment or injury or death.

- Inspect all lifting hardware (both on this machine and all ancillary lifting equipment) prior to lifting this machine.
- Never lift this machine while it is operating.
- Ensure the fuel cap is tight prior to lifting or transporting this machine.
- Only lift this machine with proper load-rated straps or slings rated for the weight and application.
- Never stand or work under a lifted machine.
- This machine is heavy. Lift using auxiliary equipment only. Do not attempt to lift this machine manually.
- Ensure a clear path to your destination and stable and clear ground before lifting.

MECHANICAL HAZARDS

⚠ WARNING Certain mechanical hazards are inherit in operating this machine due to the weight, operation, travel, and vibration of this machine. Disregarding these warnings can lead to serious injury.

- Do not operate this machine unless all protective guards are in place.
- Keep hands and feet clear of rotating and moving parts.
- Ensure the machine is OFF before removing the guards or making adjustments or repairs.
- Ensure the machine and the operator are set up on stable ground while in operation or service.
- Do not leave this machine unattended while in operation.
- When working in trenches, ensure adequate trench shoring is used to prevent collapse.
- Ensure the area in which you are working does not contain any live electrical cables, gas, water, or communication services that may be damaged by this equipment.
- Never stand on the unit while it is operating.
- Do not increase the governed no-load motor speed above 2,400 rpm; personal injury and damage to the machine may result.
- All machine and engine repairs should be conducted by a certified servicing dealership.

FIRE, EXPLOSION & THERMAL HAZARDS

⚠ WARNING Internal combustion engines contain diesel fuel and generate heat that poses certain hazards.

- Diesel fuel is extremely flammable and explosive under certain conditions.
- Ensure diesel fuel is only stored in an approved storage container.
- Do not refuel while the engine is operating or hot.
- Do not refuel in the vicinity of sparks or open flame.
- Do not refuel in confined spaces. Vapors may concentrate and ignite.
- Only fuel this machine on the ground. Do not fuel in truck beds or other areas where static electricity may be present.
- Do not overfill the fuel tank.
- Ensure the fuel cap is securely fitted after refueling.
- Avoid spilling diesel when refilling; spilled diesel or diesel vapors may ignite. If spillage occurs, clean the area per local environmental regulations prior to resuming operation.
- Avoid contact with the engine and muffler while this machine is running or while it is hot. Extreme heat may cause severe burns.
- Do not operate this product in enclosed spaces or modify it in any way that reduces engine cooling. Never attempt to restrict airflow over the engine cooling fins.
- Do not operate this machine off of gasoline; use only diesel fuel rated for Tier 4f engines.

CHEMICAL HAZARDS

⚠ WARNING Certain chemical hazards exist due to the presence of gasoline, grease, oil, and other chemicals presented by the combustion process including carbon monoxide, a colorless, odorless gas that can cause death if inhaled. Failure to follow the below instructions may lead to severe injury or death.

- Do not operate in a confined space or without adequate ventilation. Carbon monoxide exhaust gases from internal combustion engine driven equipment can cause death in confined spaces.

- Do not refuel this machine in confined spaces. Diesel vapors may be hazardous to your health, and concentrated vapors may cause an explosive atmosphere.
- Any fluids spilled from the machine, whether flammable or not, must be cleaned up in a manner consistent with all local environmental regulations.
- Always use approved fluids when maintaining or servicing this machine. Improper fluids may lead to poor performance or failures of the machine and may create a hazardous situation for the operator or bystanders. Dispose of all fluids properly in accordance with local regulations.

NOISE HAZARDS

⚠ WARNING This equipment exceeds the Occupational Safety & Health Administration (“OSHA”) safe noise levels that can cause temporary or permanent hearing loss.

- Wear an approved hearing protection device while operating this machine as required by OSHA regulations to limit noise exposure as required by OSHA regulations.
- Bystanders may also require hearing protection, depending on their distance to the machine.
- Always be visually aware of your surroundings. While operating this machine, you may not hear other auditory warnings from nearby equipment. Heightened awareness is required.

PERSONAL PROTECTIVE EQUIPMENT & HUMAN HEALTH HAZARDS

⚠ WARNING Proper personal protective equipment and operating practices are important to minimize the inherent hazards that this machine presents.

- Always wear proper protective clothing when operating this equipment, including hearing protection, respiratory protection, shatterproof eye protection, safety-toe boots, and other personal protective equipment (“PPE”) as required by OSHA or local regulations.
- Control silica dust at the source when possible using water or other suppression means.
- Exercise care when operating this unit. Exposure to vibration or repetitive work actions may be harmful to the hands and arms.
- Slip/trip/fall hazards are a major cause of serious injury and death. Beware of uneven or slippery work surfaces.
- Exercise care when working in the vicinity of open trenches, holes, or excavations.
- Never operate this equipment under the influence of drugs or alcohol. This includes prescription drugs without your doctor’s consent.
- Never operate this equipment when you are not feeling well.
- Do not attempt to operate this equipment when you are not in line of sight of the roller.

ADDITIONAL HAZARDS

⚠ WARNING It is not possible to document all of the scenarios that could result from misuse of this machine, and proper training, operation, and jobsite safety best practices should always be followed to minimize the occurrence and severity of all hazards.

- Only use this machine for its intended application.
- Always have an emergency preparedness plan, and practice it often.
- Always have a first aid kit and fire extinguisher on the jobsite. Ensure the fire extinguisher is rated for the applications, including fires caused by the combustion of gasoline and diesel.
- Do not work alone; always ensure someone else is on the jobsite with you.
- Know your jobsite address so you can give it to first responders in an emergency.

OPERATION

FAMILIARIZATION WITH THE TRENCH ROLLER & ITS COMPONENTS

Prior to operating this trench roller, it is important to be aware of the critical components, safety features, and safe operating procedure.

ARTICULATION LOCK

The articulation lock prevents the front and rear of the machine from pivoting, and it should be engaged for transportation of the roller.

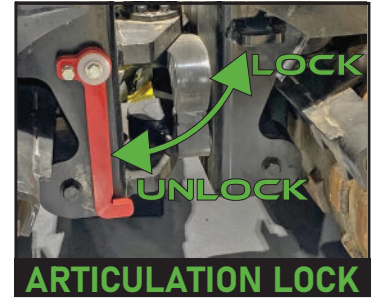

REMOTE CONTROL

The remote control is used to operate the roller and must be charged prior to by removing the battery from the remote and inserting it in to the included charging dock. To remove the battery, slide it to the side and then lift it out of the remote as indicated.

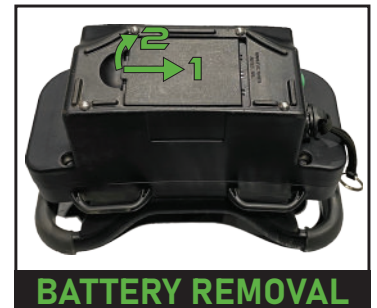

This remote key features an integrated microchip to pair the remote to the receiver in the trench roller, preventing the remote from pairing to any other roller on your jobsite. If this key is lost, your remote and roller will not function. In this case, contact your Third Coast dealer for assistance.



REMOTE FUNCTIONS:

- | | | | | |
|----------|--------------|-------------------|----------------|--------|
| Power On | Engine Start | High Engine Speed | High Vibration | Horn |
| Pairing | Engine Stop | Low Engine Speed | Low Vibration | E-Stop |

EMERGENCY STOP BUTTON

The Emergency Stop button is located on the top center of the remote control. Engaging the Emergency Stop button will immediately shut down all machine functions, including the engine.



DAILY PRE-OPERATION INSPECTION

The following inspections must be completed prior to each daily use of the trench roller and again after every four hours of machine operation.

- Visually inspect the machine for signs of damage. Remove any dirt, debris, or material that may have accumulated from prior use.
- Check all hardware to ensure proper tightness. See the “Care & Preventive Maintenance” section for proper fastener torque.

- Check the engine oil level and hydraulic oil level, and refill as needed.
- Check for fuel and hydraulic oil leaks, and repair as needed.
- Confirm the articulation lock is in the unlocked position before operation.
- Ensure the remote control battery is fully charged.



STARTING THE ROLLER

- Ensure the remote control's engine speed switch is in the  position, the vibration is in the OFF (center) position, and the Emergency Stop is disengaged prior to starting the roller.
- Cycle the glow plug by turning the roller key to the glow plug position for several seconds.
- Turn the roller key to the ON position. Do not attempt to start the engine yet. For safety reasons, the remote control must be paired at each startup before the engine can be started. NOTE: The roller's dashboard will illuminate and beep to indicate a low oil pressure fault prior to starting the engine; this is normal since the engine is not yet running.
- Power on the remote control by turning the remote key clockwise from the 0 to the 1 position as indicated on the remote control. Briefly depress the green pairing button  on the remote control to begin the pairing process. An audible "click" will be heard as the roller's relays engage, indicating the pairing is complete. NOTE: The remote control will unpair anytime the roller's key is turned to the OFF position or the remote's key is turned to the 0 position, and this process must be repeated before next operation.
- Start the engine by either holding the roller key in the START position until the engine is running, or by holding the remote control's engine start button  in the START position until the engine is running. Your roller is now ready to operate.

OPERATING THE TRENCH ROLLER

All operation of the trench roller is completed by using the remote control. There are no operator controls on the trench roller itself, other than the engine start and engine stop (which are also duplicated on the remote control). For safety considerations, the roller should never be operated while anyone is immediately adjacent to it.



ENGINE SPEED

The engine can be operated in high or low speed modes. Low speed is ideal for controlling your travel speed across terrain as you approach the area to compact. High speed is used for faster transport when it is safe to do so, or for actual compaction. Set the engine speed by positioning the engine speed switch to  for low speed or  for high speed.

FORE/AFT TRAVEL

The remote control features two joystick controls that can be used together to control fore/aft travel and to execute turns. The joysticks are position sensitive, and a shorter movement of the stick will correspond to a slower movement on the machine. To move the machine forwards or backwards, depress the left joystick upwards or downwards, respectively. To adjust the machine articulation for making turns, depress the right joystick to the right or left. The two joysticks may be operated simultaneously.

VIBRATION



The roller must be in the high engine speed position to engage the compaction excitors. To engage the excitors, toggle the exciter switch from the center "OFF" position to either the upper (high vibration) position  or lower (low vibration) position .

HORN

The roller contains a very loud audible horn to alert nearby personnel to the presence of the machine. To sound the horn, depress the horn button  located on the right side of the remote control. The horn will sound as long as the button is depressed. The horn should be used for emergency alerts only; prolonged exposure without hearing protection can cause hearing loss.

POWERING OFF THE TRENCH ROLLER

To power off the trench roller after use:

- Disengage the vibration by positioning the vibration switch to the OFF position.
- Set the engine to low speed by positioning the engine speed switch to the  position.
- Shut off the engine by either turning the roller key to the OFF position or by holding the remote control's engine switch in the off () position until the engine stops.
- Power down the roller by moving its key to the OFF position, if not already there.
- Power off the remote control by turning its key to the "0" position.
- Do not use the Emergency Stop button to shut down the machine in a non-emergency situation.

EMERGENCY SHUTDOWN PROCEDURE

The remote control is equipped with an Emergency Stop button that will stop all machine functions immediately when engaged, including shutting down the engine. To engage the Emergency Stop, depress the Emergency Stop button  fully. To release the Emergency Stop, turn the Emergency Stop button clockwise until it stops and pops slightly outward. The Emergency Stop is for emergencies only and should not be used as a routine method for shutting down the trench roller in non-emergency situations.

ADDING OR REMOVING THE DRUM EXTENSIONS

This machine features accessory drum extensions that bolt compaction width to increase from 23.5" to 33.5", for use in 24" and 36" trenches, respectively. This machine also includes extended scraper bars that help keep the drum extensions cleaned as they rotate through your substrate. The drum extensions and extended length scraper bars must be installed together to ensure proper performance.

To add the drum extensions, align them into position with the included hardware and torque each of the 5 bolts as shown to the right to 250 ft-lbs. To install the extended scraper bars, remove the standard length scraper bars first, and replace with the extended versions.

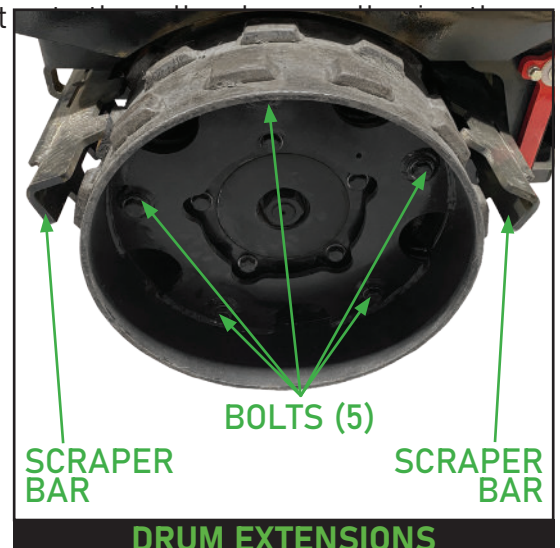

TIPS FOR PROPER COMPACTION

Trench rollers are fast, efficient tools for compacting a wide variety of substrates. The chief concern when operating a trench roller is safety, and several precautions should be followed during operation.

First, walk the jobsite prior to starting your equipment to make sure it is free of people, foreign objects, obstructions, trip hazards, and other obstacles that may impede operation or cause a safety concern. Next, when working in a trench, ensure appropriate trench shoring is always utilized. Finally, when operating the roller, always maintain line of sight to the machine. Even though the radio frequency remote does not require line of sight to operate the roller, the operator is always responsible for safe operation and ensuring there are no people or objects in the roller's path.

Proper compaction is extremely important, as it eliminates extraneous air in the substrate and reduces the transport of air and water, resulting in a more stable base with less chance of shifting or settling. Your best resource regarding proper jobsite compaction is always your jobsite engineer. If you have a jobsite engineer, always follow their specification for proper compaction.

If you do not have a jobsite engineer, you can ensure the best possible compaction with these helpful rules of thumb:

- Don't overdo it. Cracking soil indicates over-compaction. Over-compaction can break down the soil itself, resulting in a much weaker substrate than properly compacted soil. Over-compaction can also cause premature wear and tear to your roller, shortening its life.
- As you gain experience with this machine, you will understand the noises it emits and how they relate to under-compaction, proper compaction, and over-compaction. The guidance of a more experienced operator can help you build this experience, but a general rule of thumb is that over-compaction will be noisy with excessive and more erratic machine vibration. Such motion can also cause premature wear to your roller.
- Count your passes in each area, and track your areas closely. Uniform compaction is equally as important as the right amount of compaction and helps prevent uneven settling.
- If in doubt of your lift requirements, a good rule of thumb is three passes over a lift of 12" to 24" for typical soils. For very dry soils, reduce lift to 75% of the nominal. It is better to have a lower lift and fewer passes than to try to compact too large a lift with more passes.
- If in doubt of your local conditions, use a field test apparatus such as a dynamic cone test to ensure your soil is properly compacted prior to building.

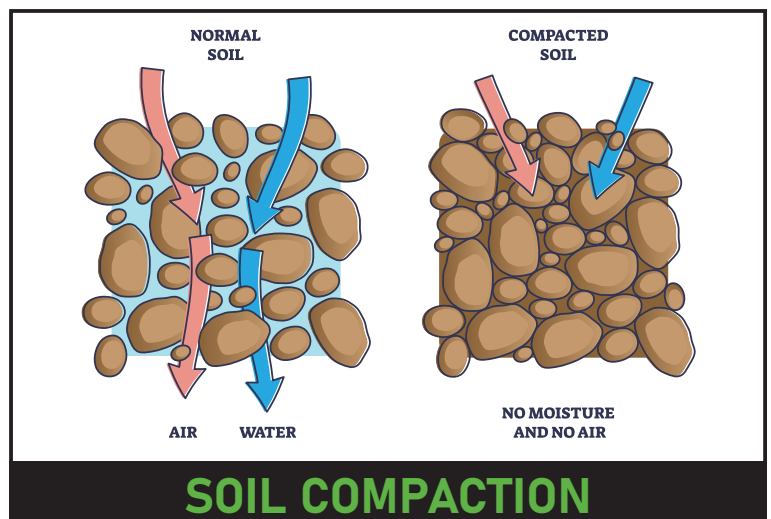

EXTENDED STORAGE

Following proper long-term storage procedures ensures the machine is ready to operate when you return to it. The following procedures should always be performed when the machine will not be in use for the next 30 days:

- Thoroughly clean the exterior of the machine with a damp rag, then dry it. Do not use solvents.
- Check and repair any leaks and tighten any loose hardware prior to storage.
- Check the engine oil and hydraulic oil levels, and top off if necessary.
- Check the engine coolant level, and top off if necessary.
- Clean the fuel filter, and drain the water from the fuel/water separator if necessary.
- Clean or replace the air filter.
- Store the machine in a clean and dry indoor storage location.

LIFTING & TRANSPORTATION

Safe lifting practices must always be followed when moving this trench roller over long distances to and from the jobsite and when moving it short distances around the jobsite.

PRIOR TO LIFTING YOUR MACHINE:

- Power down the machine.
- Ensure all hardware, including the fuel cap, is secure on the machine. Tighten any loose bolts.
- Engage the articulation lock.

TO LIFT THIS MACHINE:

- Use a single-point lift strap or hook rated for the weight.
- Attach the lift strap only through the center lift eye.
- Lift straight upwards, never at an angle.
- Never lift higher than necessary.
- Never walk underneath the machine when lifted.

TO TRANSPORT THIS MACHINE:

- When transporting over the road, always tie down the machine using straps of adequate strength secured through the front and rear tie-downs.
- Always use more than one strap to secure this machine.
- Use the tie-down points near the front and rear drum to tie down this machine.
- When transporting across the jobsite using the roller's own power, always use smooth, controlled movements and a speed appropriate to the terrain. To ascend hills, position the roller straight uphill; avoid cross-slope climbs to reduce the risk of the machine tipping over.



CARE & PREVENTATIVE MAINTENANCE

Third Coast trench rollers are designed to provide years of trouble-free service, but as with all power equipment, periodic maintenance is required to keep this machine running smoothly. Maintenance is a normal part of ownership of any machine, and must be carried out on-time per the prescribed intervals or sooner, as needed. Please note, this operator's manual is not a service guide. All service should be done by a qualified, trained service technician.

CAUTION Inspection and other service should always be carried out on hard, level ground with the engine shut down.

MACHINE INSPECTION INTERVALS

This roller must be inspected, at a minimum, at the intervals described in the "Machine Maintenance/Inspection" table below. In tough operating environments, more frequent inspection is recommended.

MACHINE MAINTENANCE/INSPECTION	
ITEM	OPERATION HOURS
Basic operation check	Every 8 hours or every day
Full visual inspection	Every 8 hours or every day
Charge remote control battery	Every 8 hours or every day
Inspect engine accessory V-belt	Every 8 hours or every day
Check hydraulic and engine oil levels	Every 8 hours or every day
Grease Articulation Joint & Steering Cylinder	Every 40 hours or weekly
Inspect scraper bars for wear, replace as needed	Every 200 hours or monthly
Exciter Oil	Lifetime lubrication - No service needed.

DAILY OPERATIONAL CHECKS

Prior to each daily use of the equipment and at the start of each operator's shift:

- Visually inspect the machine for signs of damage. Remove any dirt, debris, or material that may have accumulated from prior use.
- Clear any dust accumulation from the air filter, engine cooling fins, articulation joint, and in the control panel.
- Check all hardware to ensure proper tightness. See the "Tightening Torque Tables" section for proper fastener torque.
- Check the engine oil level, hydraulic oil level, and coolant level, and refill as needed.
- Check for fuel and oil leaks, and repair as needed.

- Check the engine coolant level, and refill as needed.
- Charge the remote control battery and confirm proper pairing of the remote control.

WEEKLY OPERATIONAL CHECKS

After each week of operation, or each 40 hours, whichever occurs first:

- Grease the articulation joint (both top and bottom pins) with NLGI No. 2 synthetic multipurpose grease.
- Grease the steering cylinder (both ends) with NLGI No. 2 synthetic multipurpose grease.

MONTHLY OPERATIONAL CHECKS

After each month of operation, or each 200 hours, whichever occurs first:

- Inspect the scraper bars for wear and cracks. If necessary, adjust the scraper bar to provide for a 1/4" to 3/8" clearance from the drums.

ENGINE INSPECTION & MAINTENANCE TABLES

To maximize the lifespan of your engine, inspect and maintain it per the schedule in the "Engine Maintenance" table below. This table is an excerpt from the engine manufacturer's manual and is not a substitute for reading your engine manual in its entirety.

ENGINE MAINTENANCE	
ITEM	OPERATION HOURS
Inspect for oil leakage	Every 8 hours or every day
Check oil level	Every 8 hours or every day
Check for loose or missing hardware	Every 8 hours or every day
Replace engine oil	First change: 50 hours Second change: 250 hours Thereafter: Every 500 hours
Clean or replace air filter	Every 500 hours, or as needed in dustier environments
Replace fuel filters	Every 500 hours

A complete list of required engine maintenance tasks can be found in your engine manual.

TIGHTENING TORQUE TABLES

The threaded fasteners on this machine are all right handed, coarse-thread, metric, Class 8.8 or Class 12.9 fasteners.

All fasteners on this machine are marked by strength class and must be torqued to the proper specification for that class. To identify whether a fastener is a Class 8.8 or Class 12.9 fastener, check the identifying marks stamped on the head.



CLASS 8.8 FASTENER



CLASS 12.9 FASTENER

TIGHTENING TORQUE FOR CLASS 8.8 FASTENERS								
THREAD SIZE>	M6	M8	M10	M12	M14	M16	M18	M20
TORQUE, FT-LB>	7	17	34	59	94	146	210	292
TORQUE, N·M>	9.5	23	49	80	127	198	285	395

TIGHTENING TORQUE FOR CLASS 12.9 FASTENERS								
THREAD SIZE>	M6	M8	M10	M12	M14	M16	M18	M20
TORQUE, FT-LB>	11	26	51	88	139	210	285	401
TORQUE, N·M>	15	35	69	119	188	285	386	544

SERVICE PARTS & FLUIDS TABLES

SERVICE PARTS & FLUIDS		
ITEM	PART/TYPE	QUANTITY
Exciter Oil	Mobile SHC 629	1.5 qt (1.4L)
Engine Oil	10W-30	3.9 qt (3.7L)
Hydraulic Oil	ISO VG 46 (AW 46)	12 gallons (46L)
Engine Air Filter	Donaldson P822686	1 filter
Engine Oil Filter	Yanmar 119305-35170	1 filter
Engine Fuel/Water Separator	Fleetguard FS1240	1 filter
Engine Small Fuel Filter	Yanmar 119802-55810	1 filter
Engine Small Fuel Filter Element	Yanmar 129053-55670	1 filter

SPECIFICATIONS

RT16 SPECIFICATIONS	
PERFORMANCE DATA	
Operating Weight, lb	4,035
Vibration Frequency, vpm	2,520
Centrifugal Force, lb	15,300
Travel Speed with Vibration, mph	0.8 - 1.5
Gradeability Maximum	50%
Drum Thickness, in	0.4
Remote Control	Radio Frequency
ENGINE DATA	
Manufacturer	Yanmar
Engine Model	3TNV80F - Diesel
Cooling	Liquid Cooled
Number of Cylinders	3
Output Power, hp	20
Operating Speed, rpm	2,400
Fuel Tank Capacity, gal	8
DIMENSIONS	
Overall Length "A", inches	75
Overall Height "B", inches	51
Overall Width (with drum extensions) "C", inches	33.5
Overall Width (without drum extensions) "D", inches	23.5
Drum Diameter "E", inches	20.5
Turning Radius (Outer), in	66

MACHINE DIMENSIONS REFERENCE DIAGRAMS

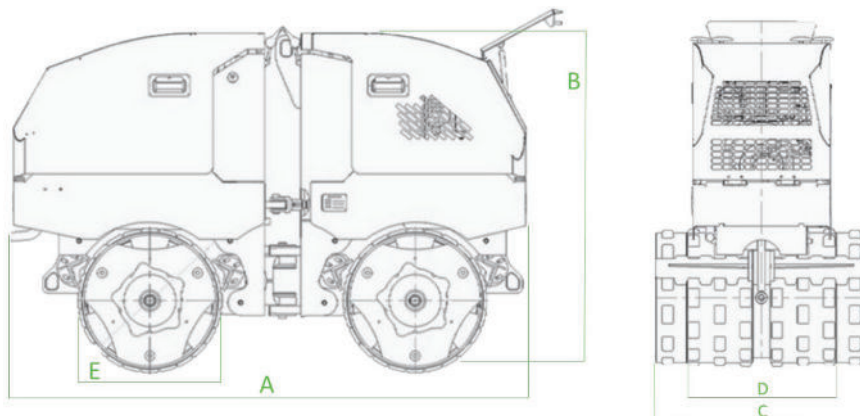

WIRING DIAGRAMS

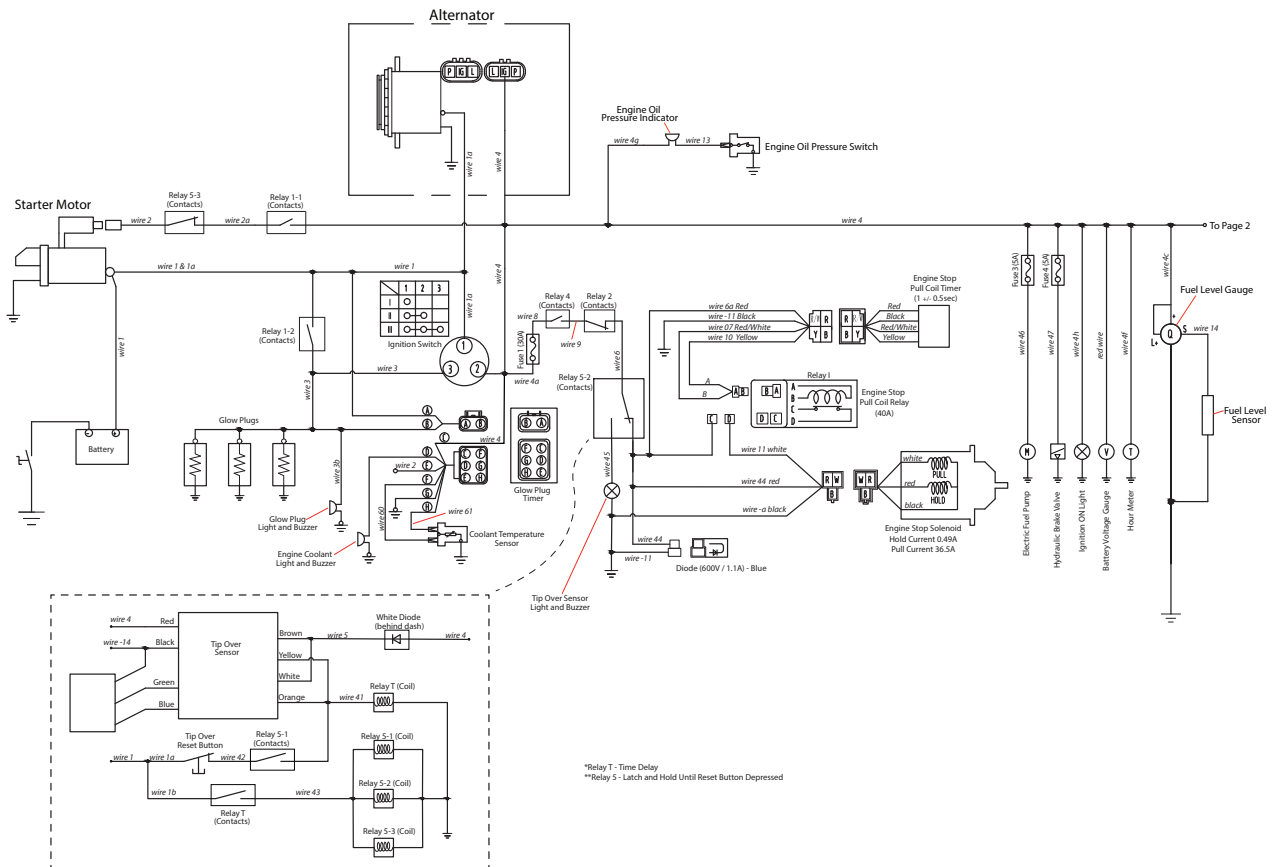

Pin Numbers for Main Connector at Bottom of Radio Receiver

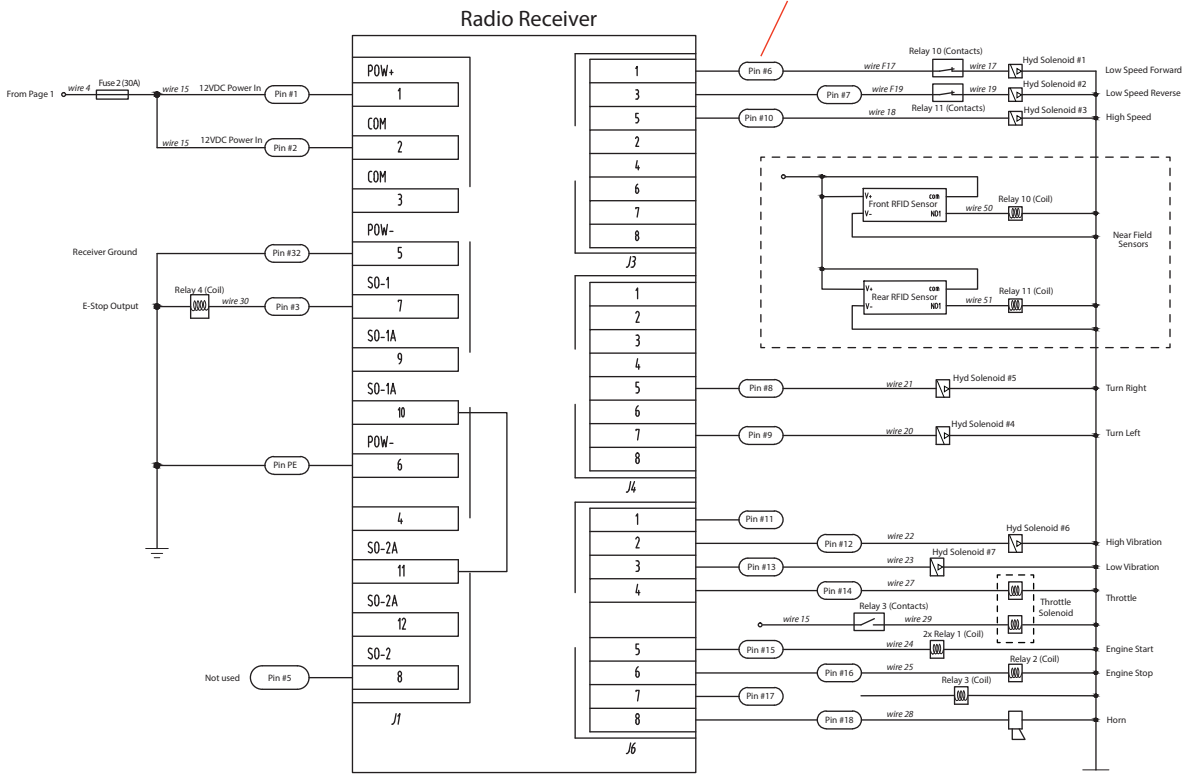

HYDRAULIC SCHEMATIC

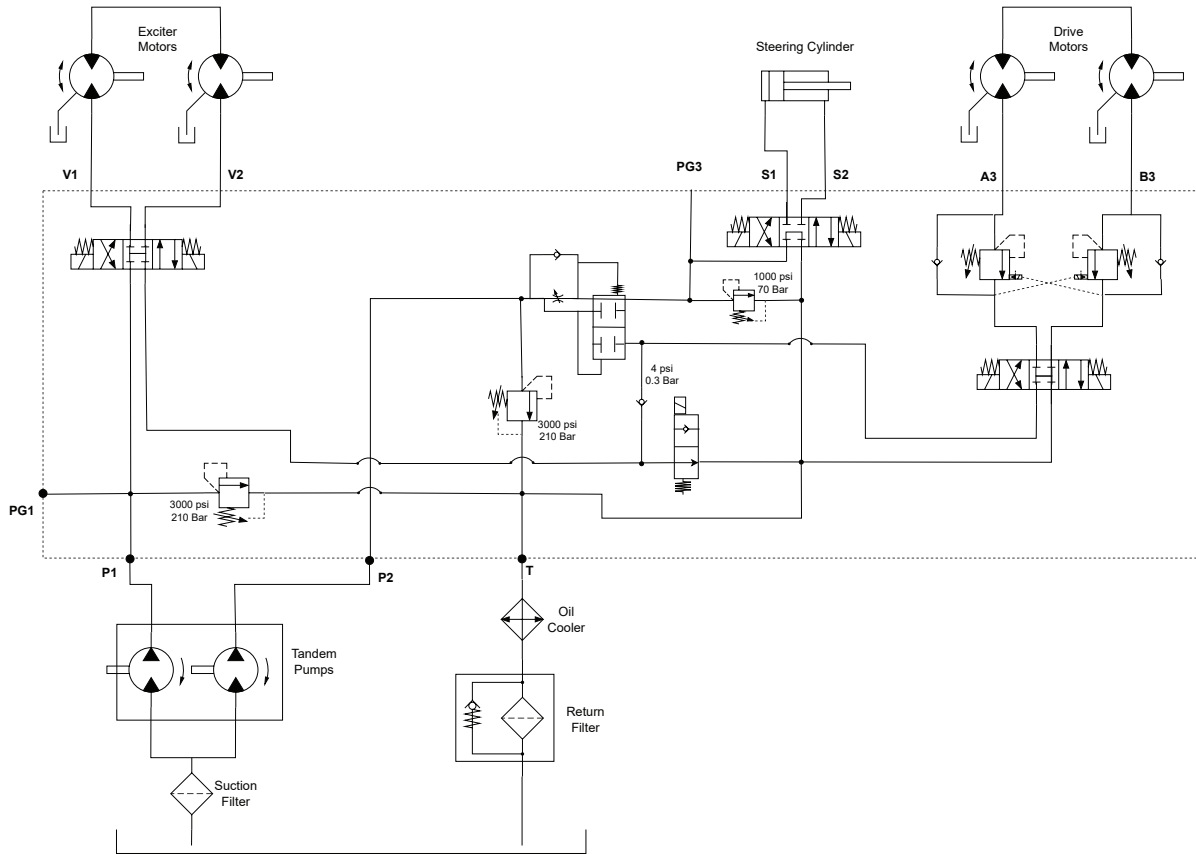

TROUBLESHOOTING

SYMPTOM	POSSIBLE CAUSE	SOLUTION
Engine does not start and will not turn over.	Key switch is in OFF position.	Turn key switch to ON position.
	Key switch on remote control is in OFF position.	Turn key switch to ON position.
	Remote control is not paired.	Pair remote control to the roller.
	Roller battery is not charged.	Check for at least 12V indicated on the voltmeter on the dash when the key is in the ON position. Charge or replace roller battery.
	Emergency Stop on remote control is engaged.	Disengage Emergency Stop by twisting it counterclockwise. Pair remote control to machine.
	Loose battery wires.	Check that both red and black main battery wires are tightly connected to the battery.
	Loose wire connection at starter.	Check that the large red wire is connected tightly at the starter terminal.
	Failed ignition switch.	Check that 12V is present on the "S" terminal on the ignition switch. Replace ignition if faulty.
	Failed starter solenoid.	Replace solenoid.

Engine does not start; it turns over but will not maintain operation.	Remote control is not paired.	Pair remote control to the roller.
	Low fuel level or bad fuel.	Check fuel level and age of fuel.
	Inadequate glow plug cycle time.	Cycle glow plugs for five seconds, and try starting engine again.
	Water is in the fuel.	Check fuel/water separator. If necessary, drain fuel system and refuel.
	Plugged fuel filters.	Check sight glass on fuel filters for debris. Replace filters if necessary.
	Air is trapped in the fuel system.	Crack open fuel lines at fuel pump and each injector. Bleed air out of lines and re-tighten fuel lines.
	Failed fuse for fuel shut off circuit.	Replace fuse.
Engine is difficult to start, or will not remain running at idle.	Low fuel level or bad fuel.	Check fuel level and age of fuel.
	Water is in the fuel.	Check fuel/water separator. If necessary, drain fuel system and refuel.
	Plugged fuel filters.	Check sight glass on fuel filters for debris. Replace filters if necessary.
	Air is trapped in the fuel system.	Crack open fuel lines at fuel pump and each injector. Bleed air out of lines and re-tighten fuel lines.
	Engine is very cold.	Extend glow plug cycle time and try starting again.
Engine will not reach full speed.	Machine is in low speed operation.	Change to high speed operation on the remote.
	Low fuel level or bad fuel.	Check fuel level and age of fuel.
	Water is in the fuel.	Check fuel/water separator. If necessary, drain fuel system and refuel.
	Plugged fuel filters.	Check sight glass on fuel filters for debris. Replace filters if necessary.
	Air is trapped in the fuel system.	Crack open fuel lines at fuel pump and each injector. Bleed air out of lines and re-tighten fuel lines.
	Engine is very cold.	Allow engine to warm up at low idle, then increase engine speed.
	Oil level is too low. Low oil cut off is engaged.	Check oil level. Refill if necessary.
	Throttle solenoid is loose, failed, or not getting 12V.	Check that the throttle solenoid is properly attached at the base and where the wire connects to the fuel pump. Check that the wires leading to the solenoid are providing 12V when the machine is put in high speed mode.
	Air filter is plugged.	Check air filter for dirt. Replace if necessary.
	Failed throttle fuse.	Replace throttle fuse #1 position - 30A.

Engine shuts off after being operated for a long period of time.	Low fuel level or bad fuel.	Check fuel level and age of fuel.
	Plugged fuel filters.	Check sight glass on fuel filters for debris. Replace filters if necessary.
	Oil level too low. Low oil cut off engaged.	Check oil level. Refill if necessary.
	Air filter plugged.	Check air filter for dirt. Replace if necessary.
	Machine battery drains because the charging circuit is faulty.	Check the charging circuit is providing >13.5V when the engine is running at high speed.
	Remote battery is drained.	Replace with a fully charged battery.
Engine operates normally but will not transmit any power to the drums.	Low hydraulic oil level.	Check hydraulic oil level with sight glass on tank. Refill if necessary.
	Hydraulic solenoids are not activating.	Check that the red LED lights when a function on the remote is activated. Contact a certified dealer for assistance if it does not.
	Proximity sensor is activated.	Have the operator move away from the machine to deactivate the proximity sensor.
	Leaking hydraulic hoses.	Check for leaks in the hydraulic hoses and fittings. Repair if necessary.
Machine will not move.	The proximity sensor is activated.	Have the operator move away from the machine to deactivate the proximity sensor.
	Dirt and debris build up on drums.	Clean built-up dirt and debris off the drums, around the scraper bars, and between the drums and hub assembly.
Short range of control with the remote.	Low remote battery.	Replace with a fully charged battery.
	Receiver antenna is disconnected.	Check that the black antenna is attached to the yellow radio receiver located under the rear hood.

WARRANTY



Third Coast Equipment stands behind all of its products with a best in class warranty, including:

- Five-year warranty on spare parts
- Four-year warranty on Vanguard engines
- Three-year warranty on Honda engines
- Two-year warranty on labor

This limited warranty contains certain exclusions and limitations and is restricted to repair or replacement of the machine or affected parts only. Other exclusions may apply.

To view the full Third Coast Equipment warranty policy, visit:

[HTTPS://THIRDCOASTEQUIPMENT.COM/WARRANTY-POLICY](https://thirdcoastequipment.com/warranty-policy)

THIRD COAST EQUIPMENT



3CE Dealer Card

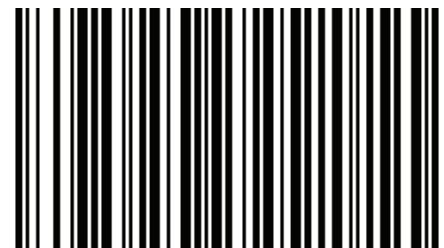

RT-0M-02

THIRD COAST EQUIPMENT, INC.
NEW BERLIN, WI
THIRDCOASTEQUIPMENT.COM